

System: Lauf- und Führungsschiene aufgeschraubt, ohne Korpusbearbeitung, für zwei Holztüren bis 40 kg. Design Flächenbündig /Forslide

System: Running and guide track screwed on, without cabinet modification, for two wooden doors up to 40 kg. Flush design /Forslide

Système: rails de roulement et de guidage vissés, aucune préparation nécessaire le corps de meuble, pour deux portes en bois jusqu'à 40 kg. Pour deux portes en bois jusqu'à 20 kg. Design affleurant /Forslide

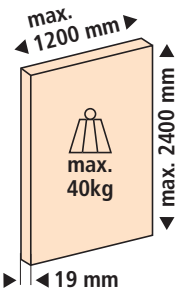

Abkürzungen/Abbreviations/Abréviations

TH	Türhöhe	Door height	Hauteur de porte
TB	Türbreite	Door width	Largeur de porte
H	Höhe	Height	Hauteur
W	Position Führung	Guide position	Position guidage
X	Bohrung Frontbefestigung	Drill hole front fixing	Perçage fixation de la face
Y	Bohrung Position Steuerkurve	Drill hole position radial cam	Perçage position came de commande
Z	Kante Position Steuerkurve	Edge position radial cam	Bord position came de commande
U	Position Führungsschiene	Position guide track	Position rail de guidage

Einbaugrößen/Installation dimensions/Dimensions de montage

- Typ S** = KAM 1200-1799
- Typ M** = KAM 1800-2199
- Typ L** = KAM 2200-2400

Übersicht/Overview/Synopsis: 18

In 4 Minuten fertig geplant und bestellbereit
Planned and ready for ordering in 4 minutes
Planifié et prêt à être commandé en 4 minutes

www.eku.ch/planningtools

Einbaubeispiele/Mounting examples/Exemples de montage

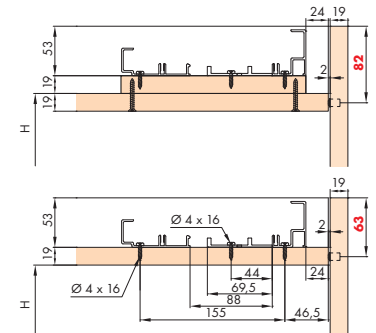
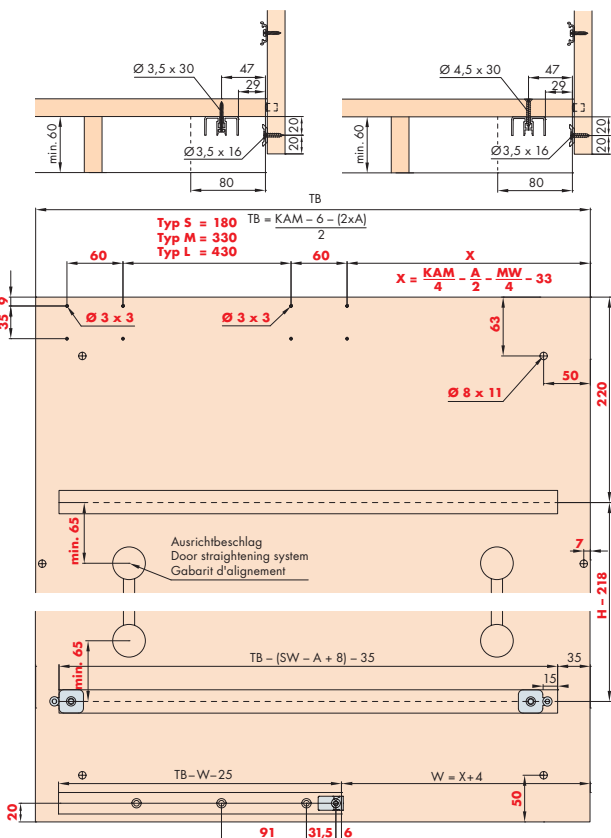

D

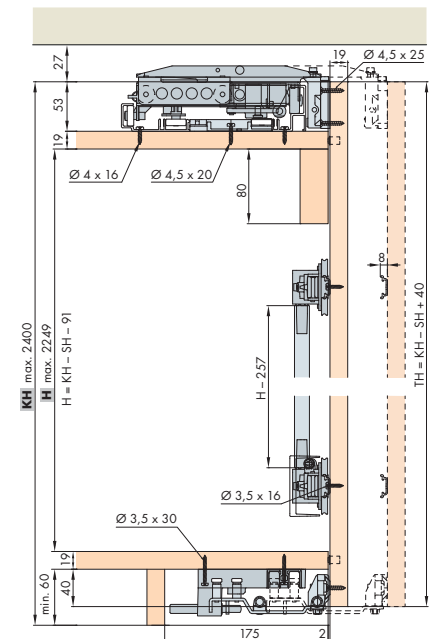
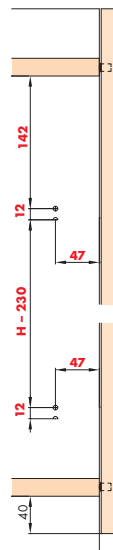

Bearbeitung = rote Zahlen/Preparation = red numbers/Préparation = numéros en rouge

EKU FRONTINO® 40 H Forslide (FS)

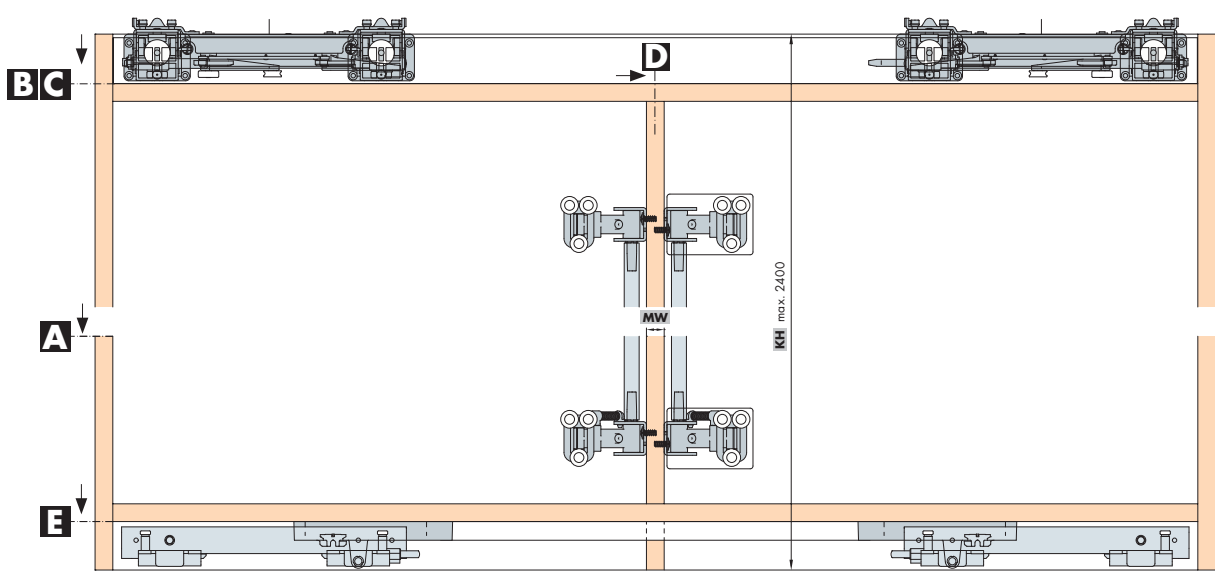
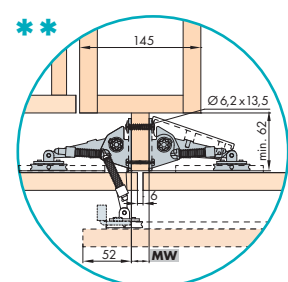
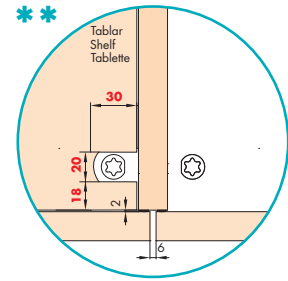
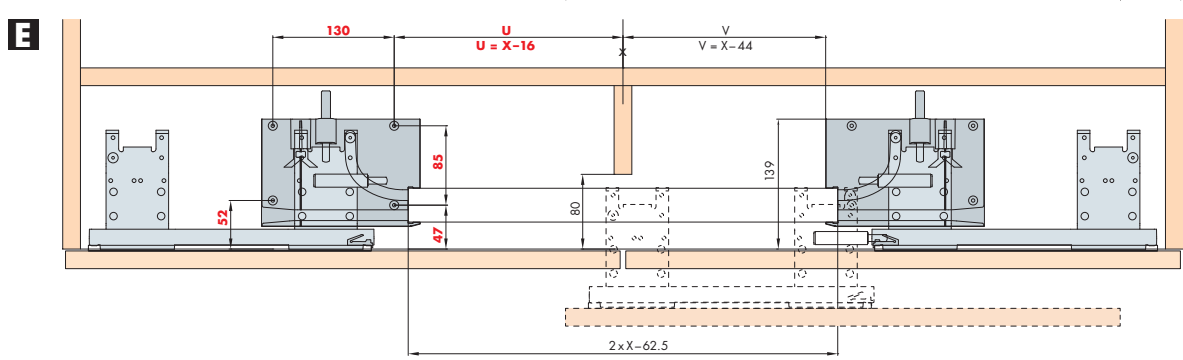
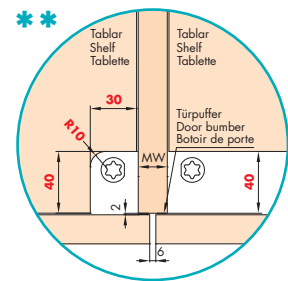
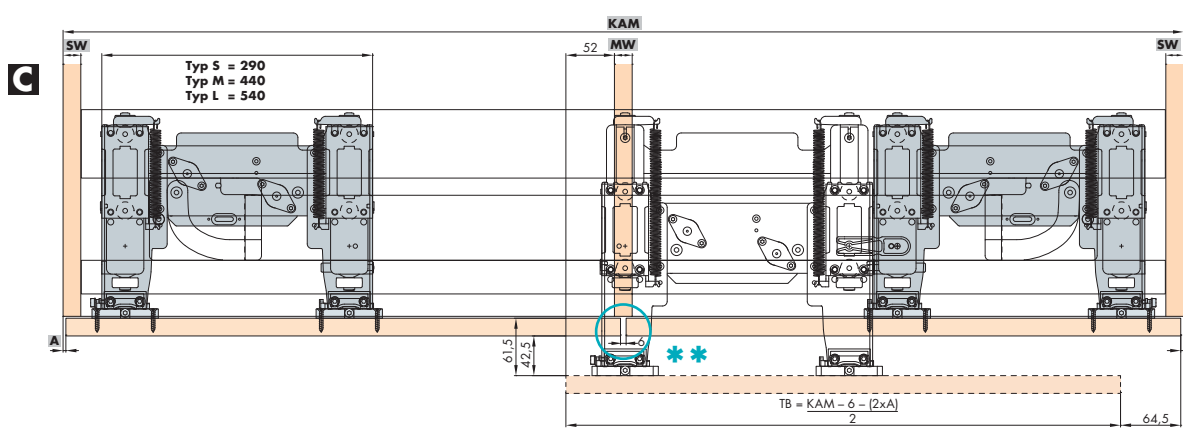
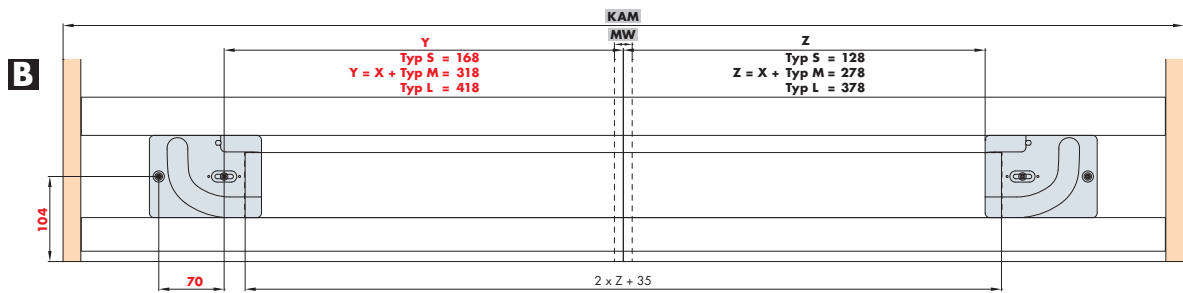
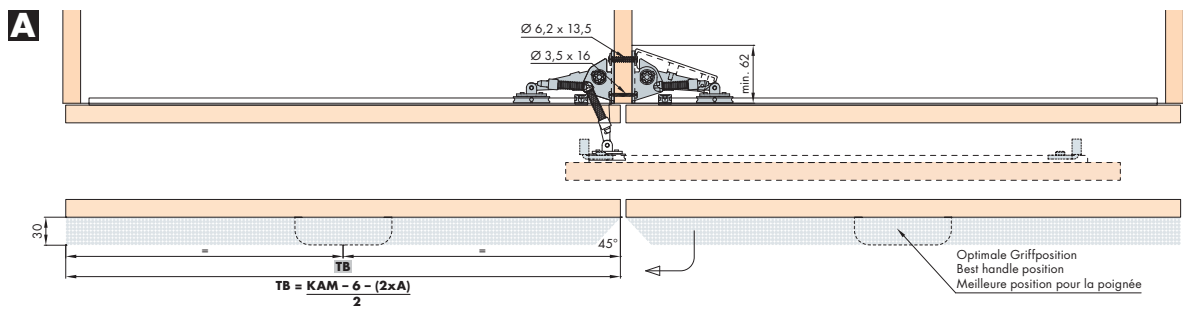

Mit Auszug/Schublade
 With pull-out/drawer
 Avec extension/tiroir

Übersicht/Overview/Synopsis

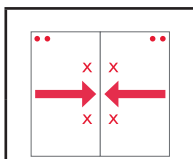

Garnituren/Sets/Garnitures

053.3320.071	KAM 1200-1799 mm	Typ S	•
053.3320.072	KAM 1800-2199 mm	Typ M	•
053.3320.073	KAM 2200-2400 mm	Typ L	•

Zubehör/Accessories/Accessoires

053.3321.180	Schienset Track set Set de rails KAM 1200-1799 mm	Typ S	•
053.3321.220	Schienset Track set Set de rails KAM 1800-2199 mm	Typ M	•
053.3321.240	Schienset Track set Set de rails KAM 2200-2400 mm	Typ L	•

In 4 Minuten fertig geplant und bestellbereit

Planned and ready for ordering in 4 minutes
Planifié et prêt à être commandé en 4 minutes

www.eku.ch/planningtools

Garnitur/Set/Garniture

2 Türen Doors Portes	Typ S = KAM 1200-1799 mm	No. 053.3320.071
	Typ M = KAM 1800-2199 mm	No. 053.3320.072
	Typ L = KAM 2200-2400 mm	No. 053.3320.073
		1x
		1x
		1x
		1x
		1x
		1x
		1x
		1x
		1x
		1x
		2x
		1x
		1x
		1x
		1x
		1x
		2x
		1x
		1x
		4x
		4x

Zubehör/Accessories/Accessoires

Schienset für Korpusbreite von 1200-1799mm

Alu eloxiert und Kunststoff, gelocht

Track set for cabinet widths 1200-1799 mm
aluminium anodized and plastic, perforated

Set de rails pour largeur de corps de meuble de 1200-1799 mm
alu anodisé et plastique, perforé

Typ S 1800 mm 053.3321.180

Schienset für Korpusbreite von 1800-2199 mm

Alu eloxiert und Kunststoff, gelocht

Track set for cabinet widths 1800-2199 mm
aluminium anodized and plastic, perforated

Set de rails pour largeur de corps de meuble de 1800-2199 mm
alu anodisé et plastique, perforé

Typ M 2200 mm 053.3321.220

Schienset für Korpusbreite von 2200-2400 mm

Alu eloxiert und Kunststoff, gelocht

Track set for cabinet widths 2200-2400 mm
aluminium anodized and plastic, perforated

Set de rails pour largeur de corps de meuble de 2200-2400 mm
alu anodisé et plastique, perforé

Typ L 2400 mm 053.3321.240

Gr./Size Art. No.

1x		49 x 36 mm
1x		30 x 73 mm
2x		8 x 25 mm
1x		67 x 10 mm
2x		Ø 16 x 2000 mm
2x		23 x 5 mm
1x		29 x 15 mm