

ARC12 CD/U5

SPECIAL APPLICATION PROFILE
PROFIL SPECJALNY

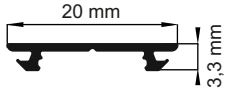

max
12 mm



20 mm

3,3 mm

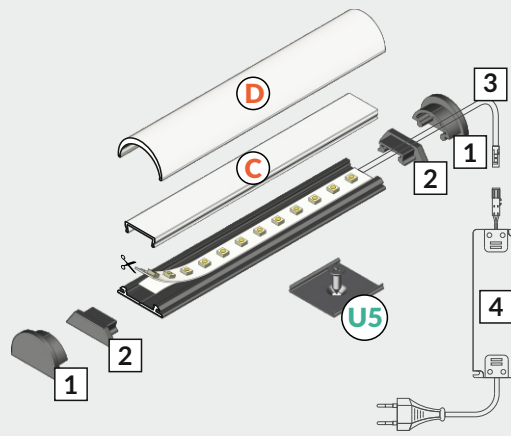

D D slide cover
klosz D wsuwany

C C click cover
klosz C klik

U5 cone U5
mounting plate
uchwyt U5 cone

1 ARC12
D ending
zaślepka
ARC12 D

2 ARC12
ending
zaślepka
ARC12

3 power supply
cable
kabel zasilania

4 LED power
supply
zasilacz LED



pliers
kombinerki



hacksaw
piła



soldering iron
lutownica



solder
cyna



drill
wiertarka



screwdriver
śrubokręt

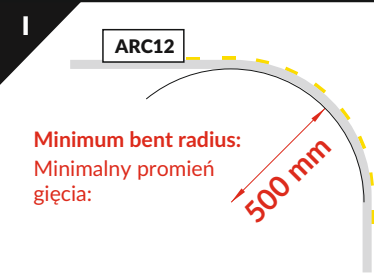

Minimum bent radius:
Minimalny promień
gięcia:

500 mm

Note! When bending to the outside (picture on the left), the needed length of the cover is greater than the length of the profile.

Uwaga! W przypadku gięcia profilu na zewnątrz (patrz rys. po lewej) potrzebna długość klosza jest większa niż długość profilu.

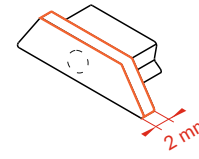
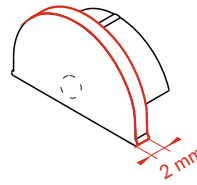

Note! Endings with marked space to bore a hole.

Uwaga! Zaślepki z punktem do przewiercenia otworu.

Note! Ending thickness increases the length of the luminaire by 2 mm each side.

Uwaga! Grubość zaślepki zwiększa długość oprawy o 2 mm z każdej strony.

MANUAL BENDING / RĘCZNE GIĘCIE

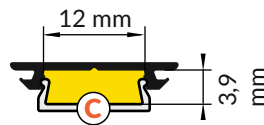
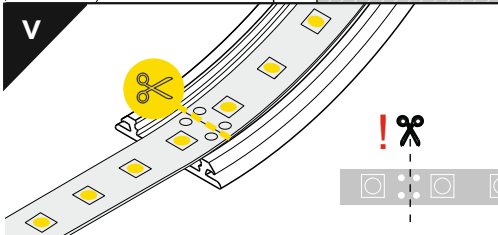
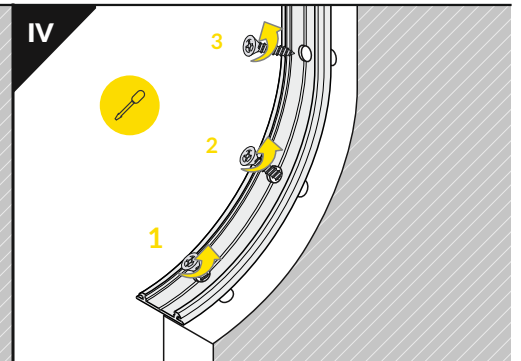
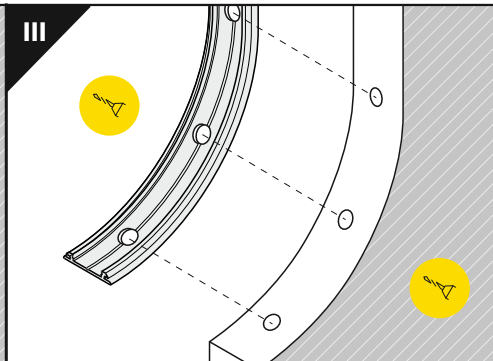
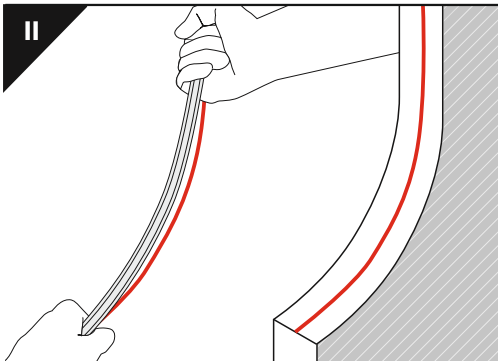

Dimensions of the space to install LED source. / Wymiary przestrzeni do zamontowania źródła LED.

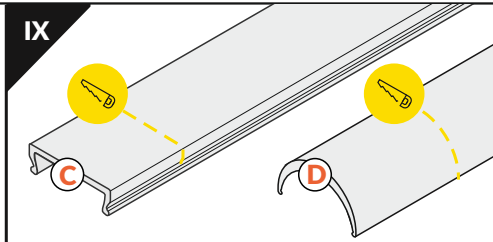
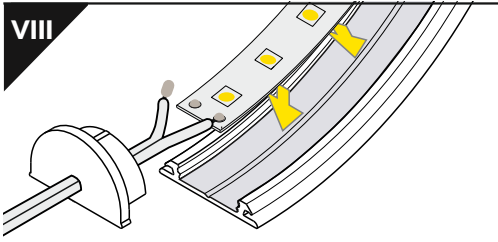
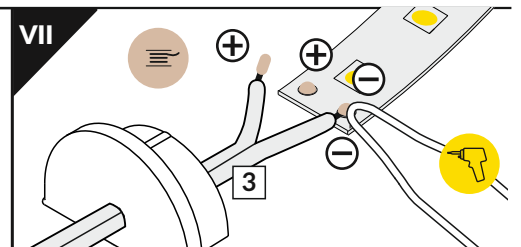
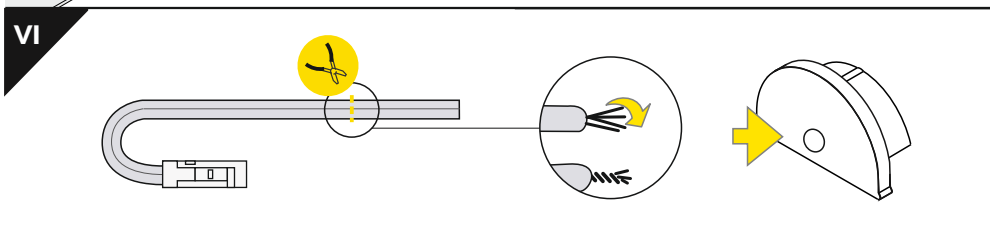
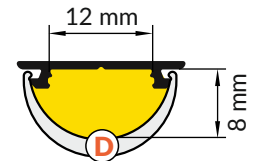

VI



C click cover / klosz C klik

D slide cover / klosz D klik

C + D for maximum light diffusion
dla maksymalnie rozproszonego światła

VII MOUNTING / MONTAŻ

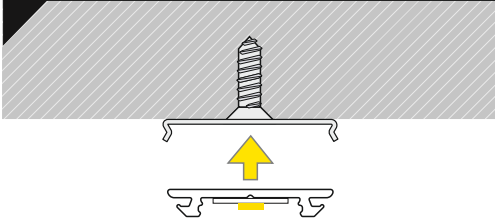
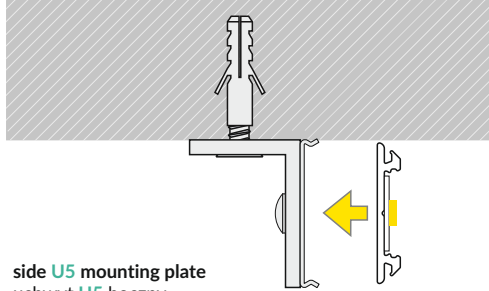
cone U5 mounting plate
uchwyt U5 coneside U5 mounting plate
uchwyt U5 boczny

SLING / ZAWIESIE

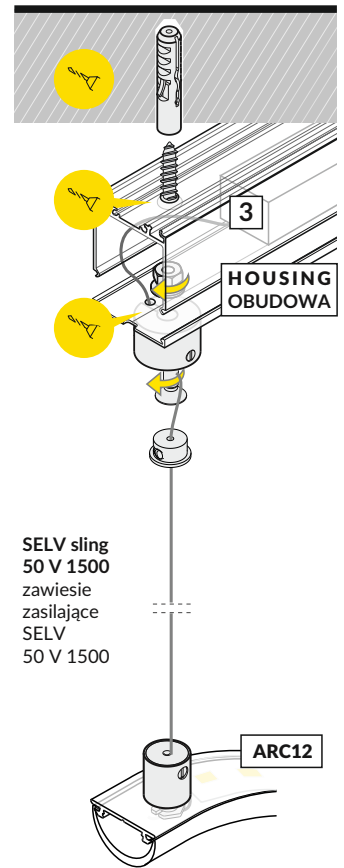
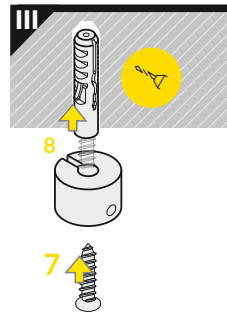
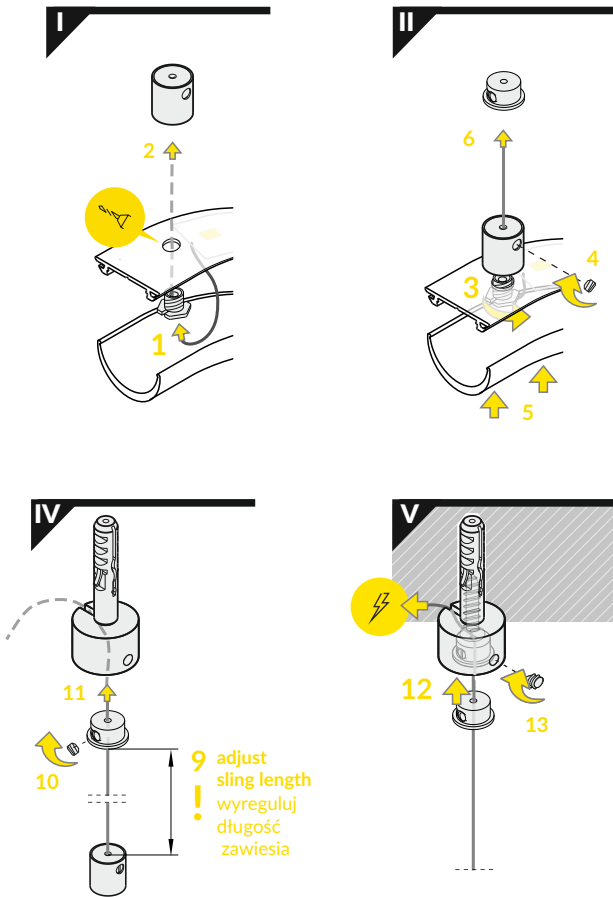
SELV sling 50 V 1500
zawieszanie zasilające SELV 50 V 1500SELV sling + LED power supply housing
zawieszanie SELV + obudowa na zasilacz

IX

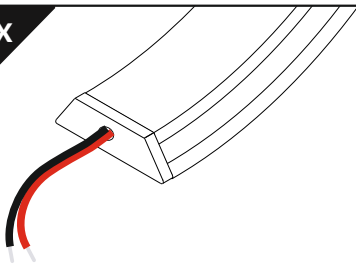

12V/24V

230V

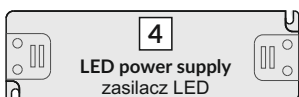

ACCESSORIES / AKCESORIA

- power switches
- controller + remote
- movement sensors
- włączniki
- sterownik + pilot
- czujniki ruchu

Check the rest - TOPMET catalogue or www.topmet.co.uk
Zobacz więcej - katalog TOPMET lub www.topmet.pl

www.topmet.pl