

Quadro für Holzschubkästen

Quadro for wooden drawer

Push to open Synchro/Multisynchronisation

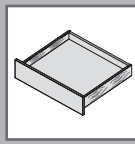

Technik für Möbel



i

1

2

3

Quadro V6
Quadro V6 YOU
Quadro 4D V6

Quadro 25

1a

L					
EB 20		EB 21	EB 23		
Quadro 25	Quadro V6	Quadro 4D V6	Quadro V6 YOU	Quadro 25	Quadro V6
LB - 89	LB - 89	LB - 93	LB - 91	LB - 95	LB - 95

1

2

1b

L
X + Y + 2

2

3

2

2

Quadro V6
Quadro 4D V6
Quadro V6 YOU

Quadro 25

Push to open Multisynchronisation

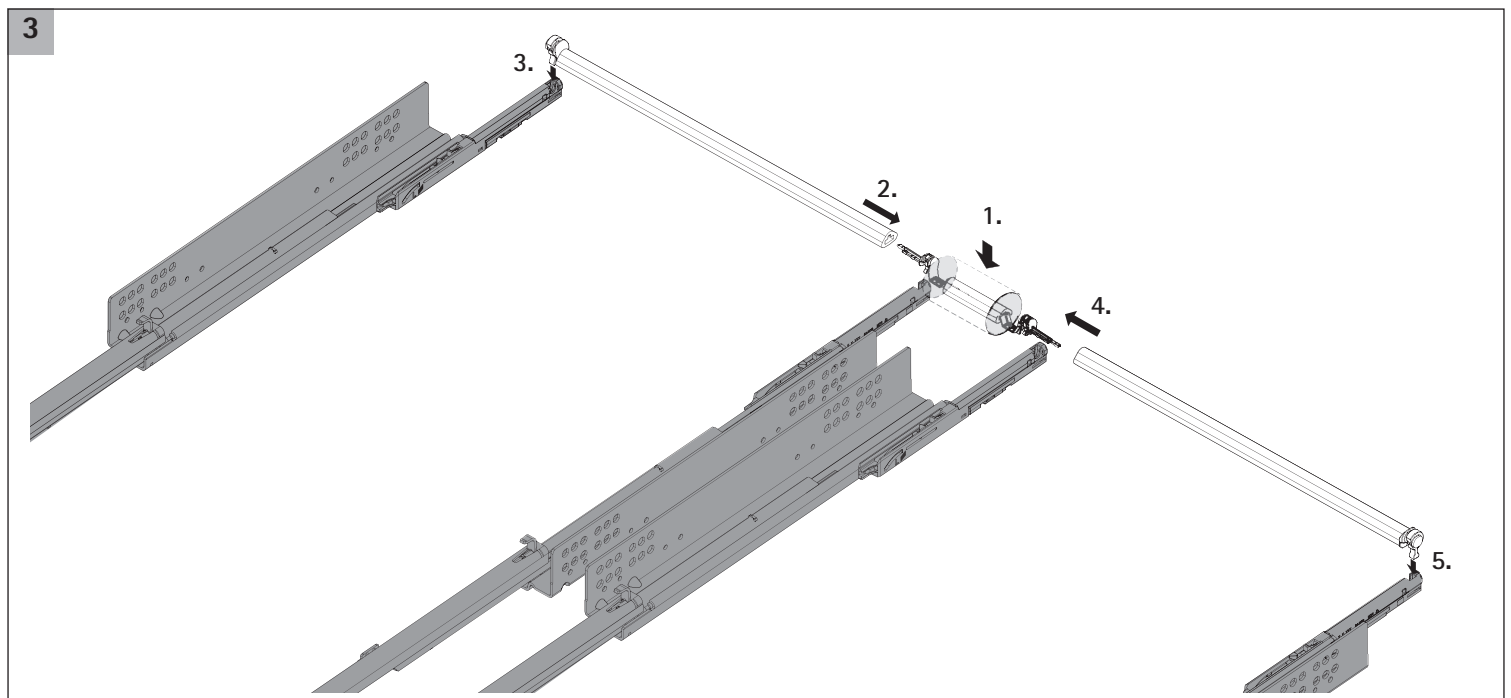
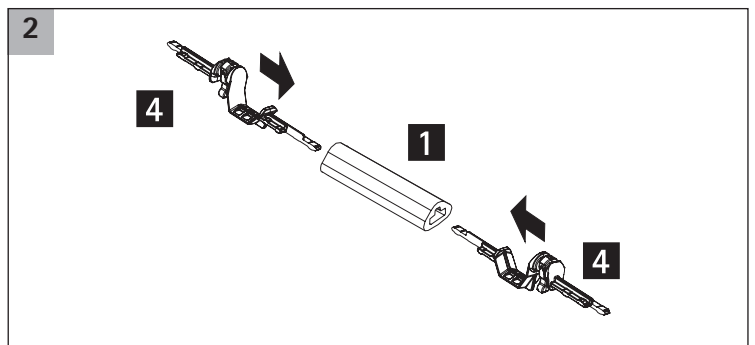
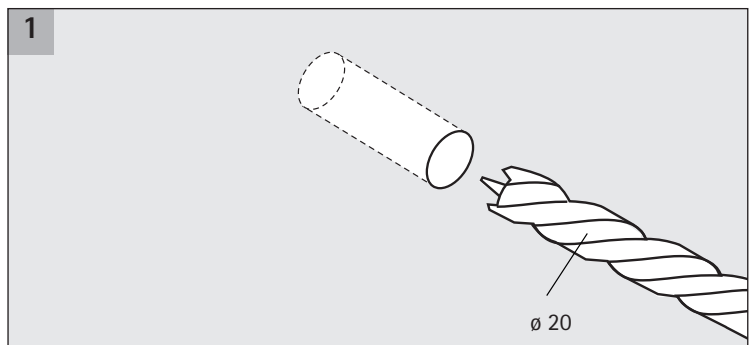
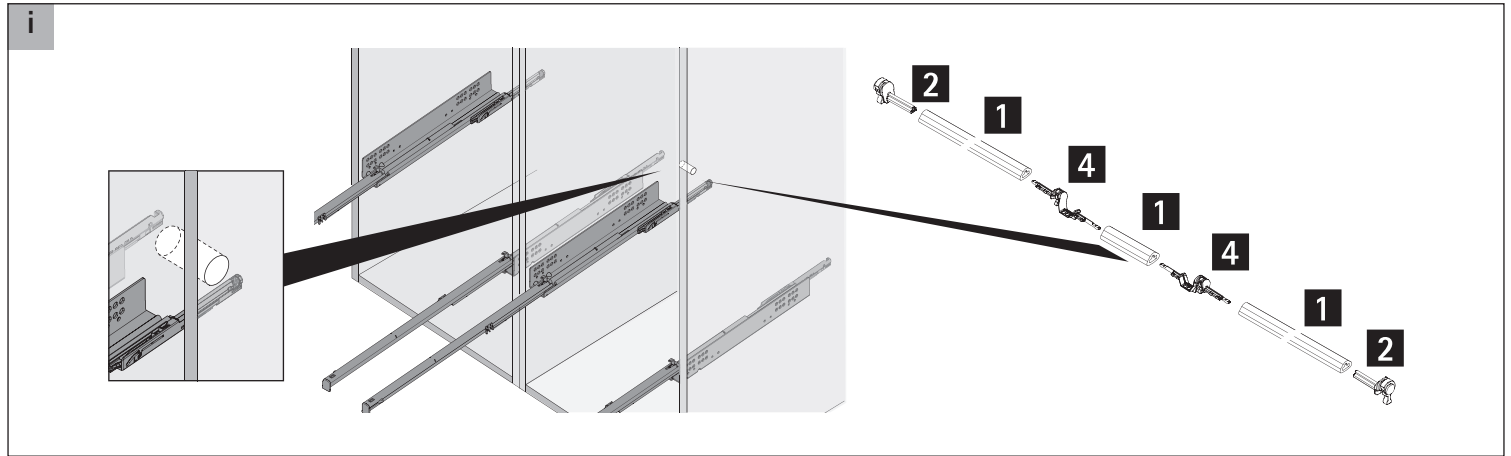
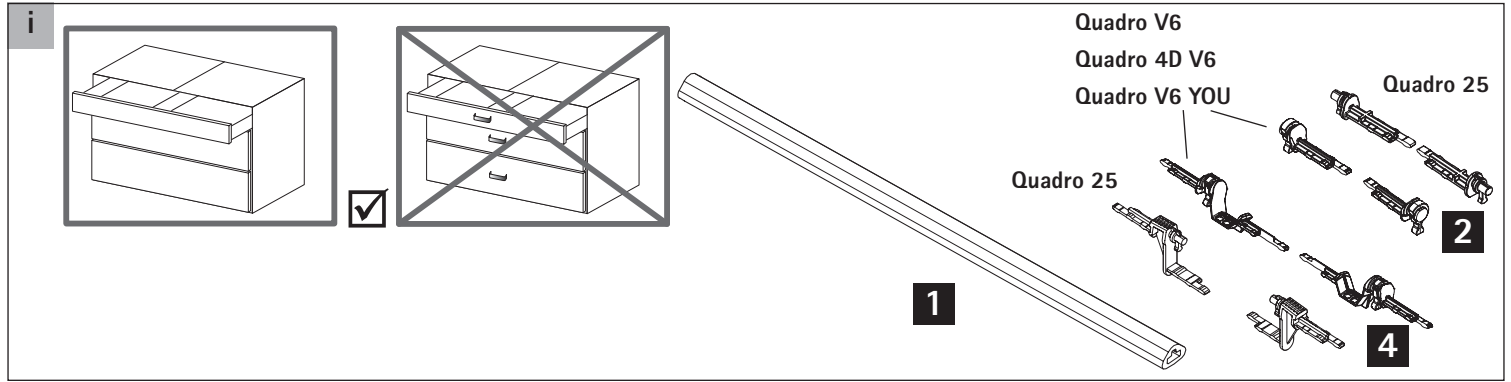

i

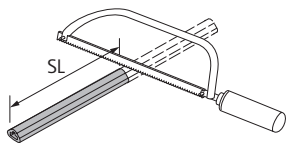
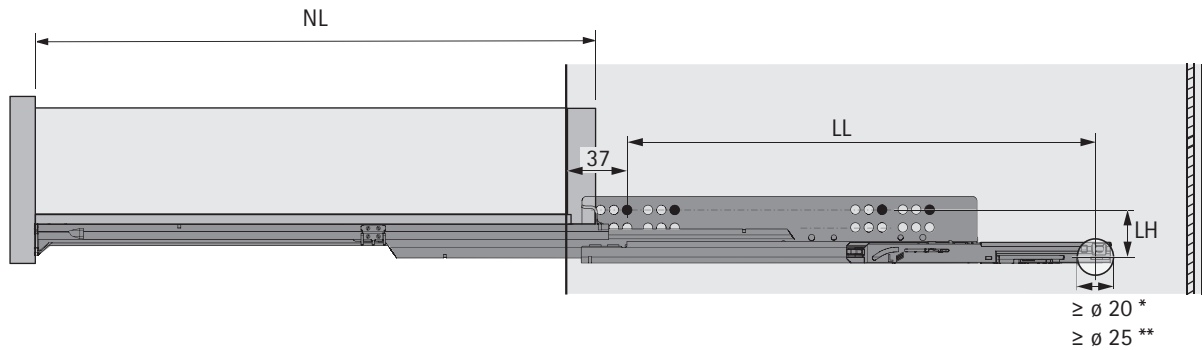

Quadro V6 YOU / V6:
 $SL = KD + 2 \times EB - 6$

Quadro 4D V6:
 $SL = KD + 2 \times EB - 2$

Quadro 25:
 $SL = KD + 2 \times EB + 31$

* Quadro V6 YOU / Quadro 4D V6 / Quadro V6
 ** Quadro 25

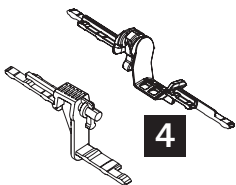
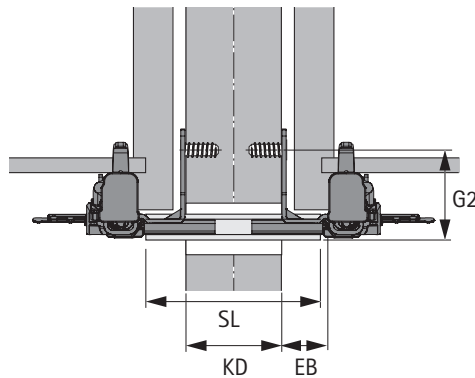
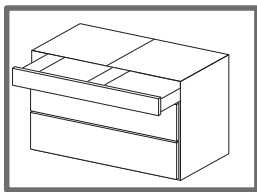

Quadro V6 YOU														
NL mm	250	270	300	320	350	380	400	420	450	480	500	520	550	600
LL mm	204	204	204	247	247	322	340	346	369	369	394	394	430	437

Quadro 4D V6														
NL mm	250	300	320	350	380	400	420	450	480	500	520	550	580	600
LL mm	209	257	257	302	341	341	371	371	437	437	437	437	443	443

Quadro V6														
NL mm	250	300	320	350	380	400	420	450	480	500	520	550	580	600
LL mm	209	257	257	302	341	341	371	371	395	395	437	437	443	443

Quadro 25														
NL mm	250	300	320	350	380	400	420	450	480	500	520	550		
LL mm	169	169	169	214	214	214	236	236	236	251	251	274		

	LH mm		G2 mm
Quadro V6 YOU	33	Quadro V6 YOU	40
Quadro 4D V6	33	Quadro 4D V6	40
Quadro V6	33	Quadro V6	40
Quadro 25	50	Quadro 25	57

