

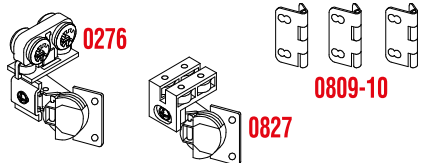

Sistemi scorrevoli per armadi / Folding systems for furniture

## KIT 0276-827



## KIT 0277-827

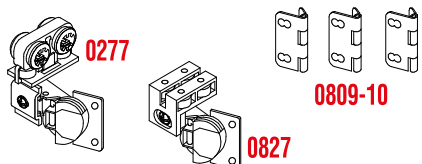

## KIT 0276-267

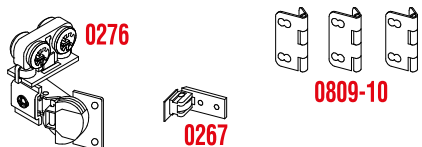

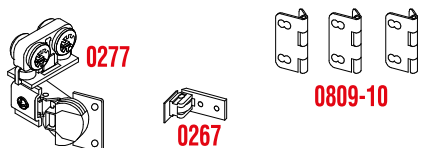

## KIT 0277-267



### Legenda KIT / Kit Legend

<b>0276</b>	Carrello superiore a rulli con 1 cerniera <i>Upper truck with rollers with 1 hinge</i>
<b>0277</b>	Carrello superiore a cuscinetti con 1 cerniera <i>Upper truck with ball bearings with 1 hinge</i>
<b>0267</b>	Rotella inferiore <i>Lower roller</i>
<b>0827</b>	Guida inferiore con 1 cerniera <i>Lower runner with 1 hinge</i>
<b>0809-10</b>	Cerniera simmetrica-asimetrica con bussole <i>Symmetric-asyymmetric hinge with bushes</i>

### Legenda altri componenti Legend other items

<b>0120</b>		Profilo alluminio superiore <i>Upper aluminium profile</i>
<b>0823</b>		Profilo alluminio inferiore <i>Lower aluminium profile</i>

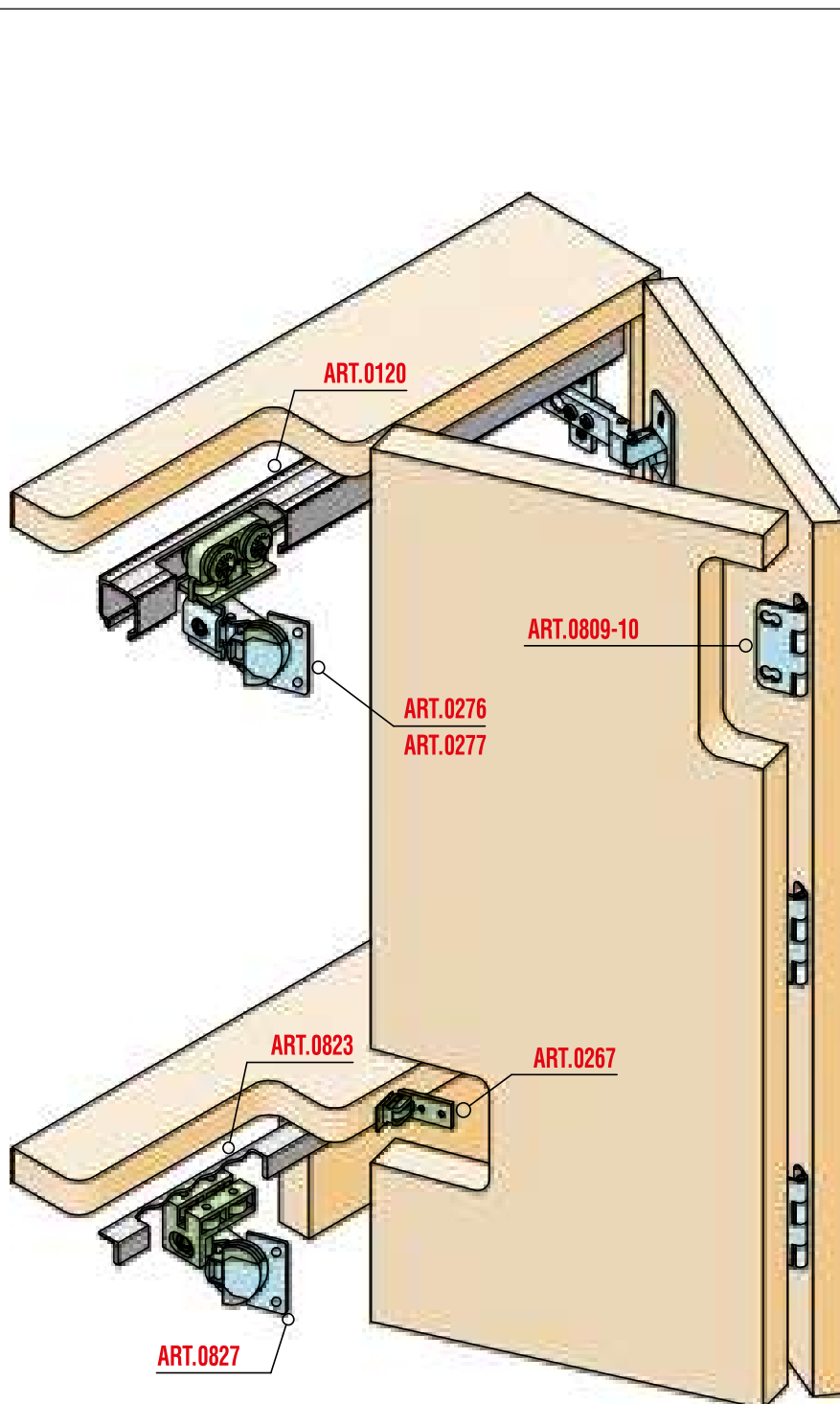

## Sezione verticale / Vertical section

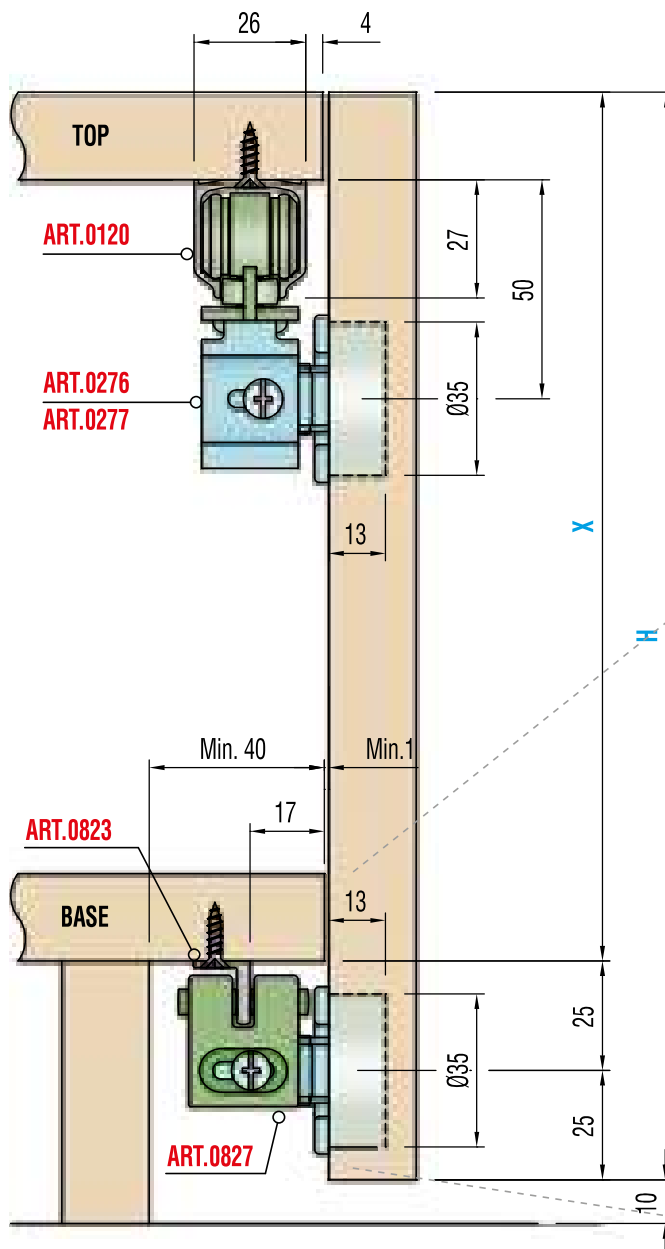

DIMENSIONI ANTE DIMENSIONS OF THE DOORS	
Altezza Height	max. 2000 mm.
Larghezza Width	max. 300 mm.
Spessore Thickness	min. 16 mm. - max. 30 mm.

### Variante Special version

Con guida inferiore all'interno del mobile  
With lower runner inside the wardrobe

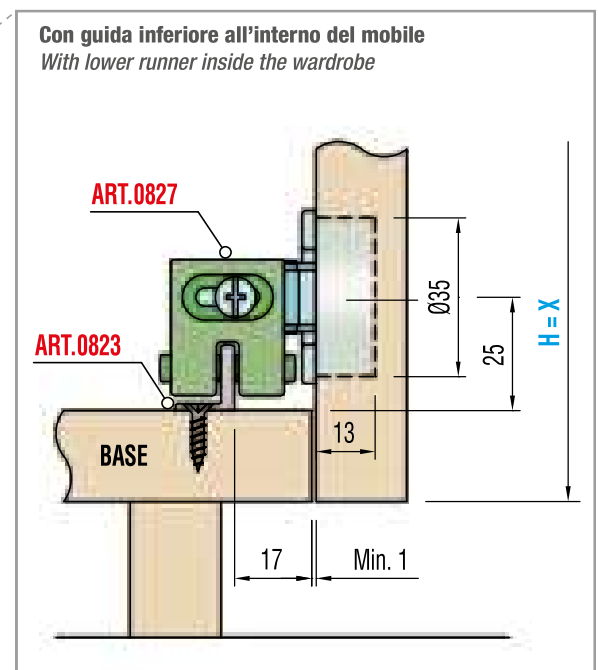

$$H = X + 50$$

## Posizione di montaggio cerniere centrali art. 0809-10

Assembling position of the centre hinges art. 0809-10

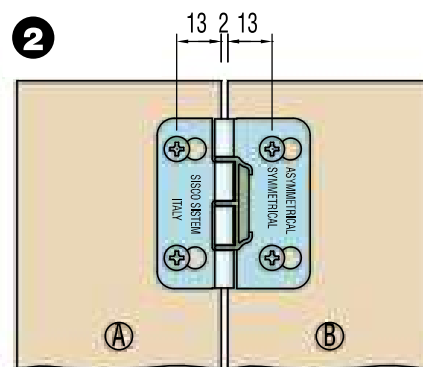
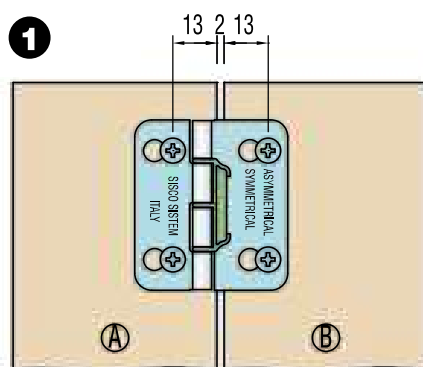

Per il corretto funzionamento del sistema, Vi consigliamo l'uso di cerniere laterali con apertura a 110°, in abbinamento alle cerniere centrali, ART.0809-10, montate in modo asimmetrico (1). Se invece utilizzate cerniere laterali con apertura a 90°, montate le cerniere centrali, ART.0809-10, in modo simmetrico (2).

To ensure a proper functioning of the system, we suggest you to use side hinges with 110° opening, along with centre hinges, ART.0809-10, asymmetrically fitted (1). If you use side hinges with 90° opening, fit centre hinges, ART.0809-10, symmetrically (2).



Sistemi scorrevoli per armadi / Folding systems for furniture

## Schema foratura ante / Doors drilling

CON GUIDA INFERIORE ALL'INTERNO DEL MOBILE / WITH LOWER RUNNER INSIDE THE WARDROBE

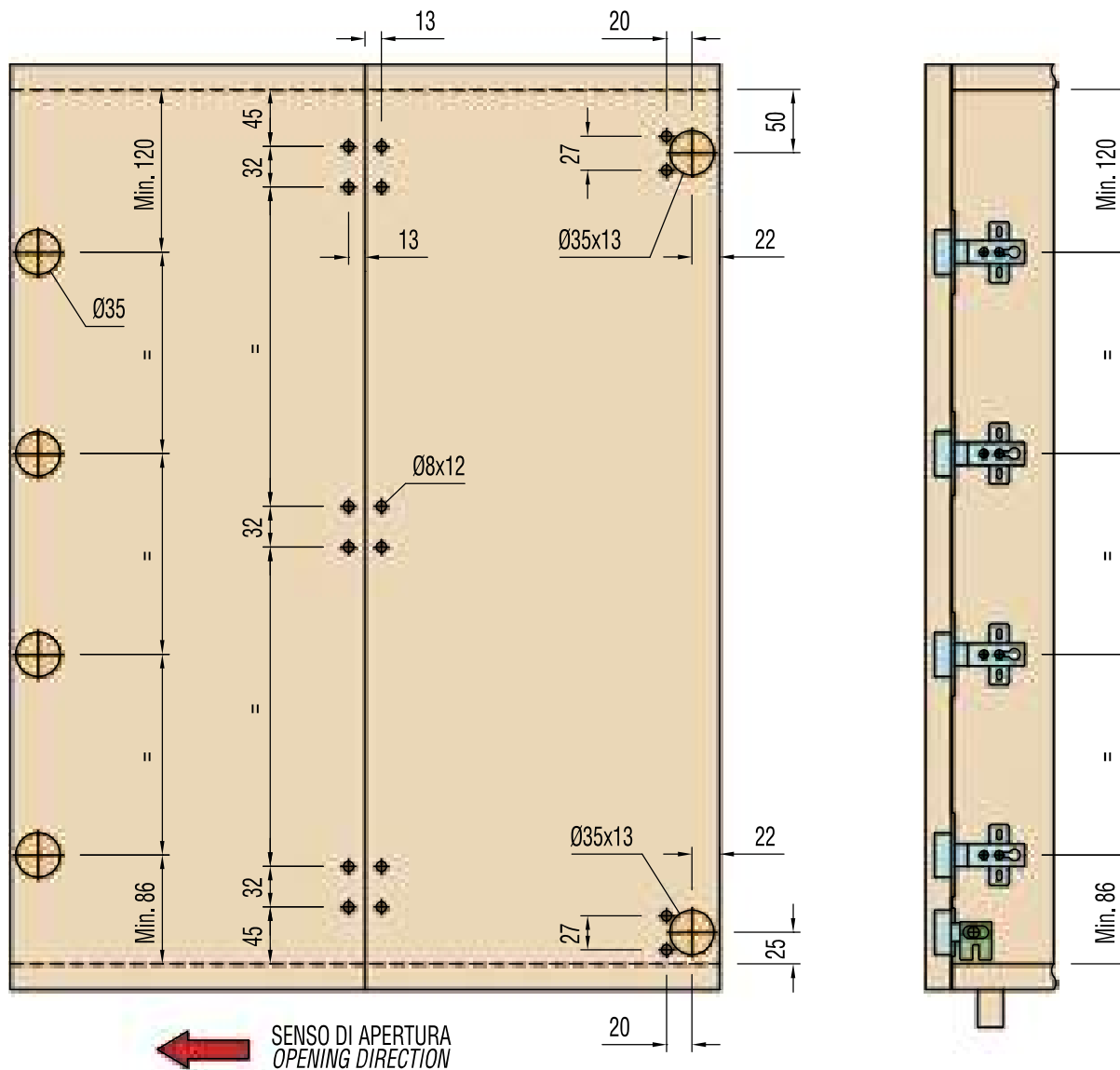

Con guida inferiore all'esterno del mobile / With lower runner outside the wardrobe

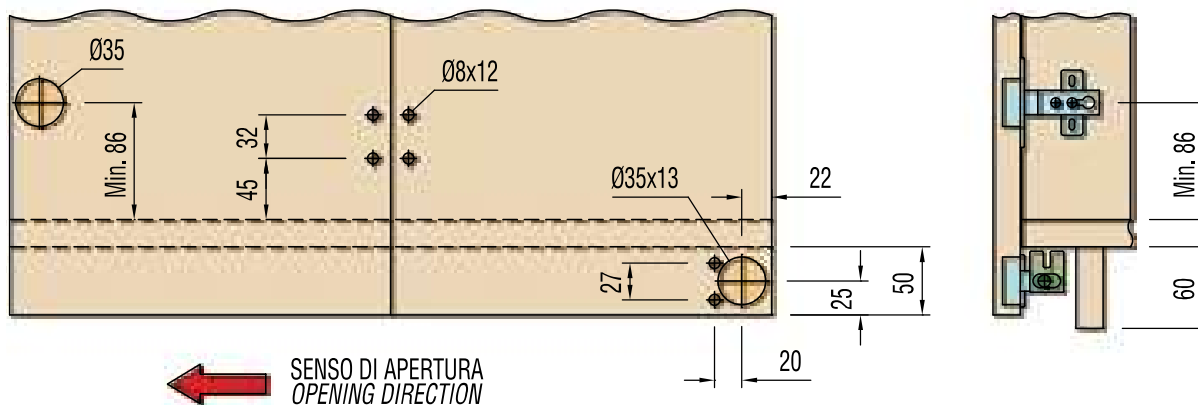

Il peso delle ante deve essere sostenuto dalle cerniere laterali montate sulla spalla del mobile e non dal carrello superiore, che ha la sola funzione di guida. Consultate il vostro fornitore per determinare quante cerniere devono essere montate sulla spalla del mobile, in funzione delle dimensioni e del peso delle vostre ante.

The weight of the doors is born by the side hinges fitted to the wardrobe side, not by the upper truck which only functions as a guide. Turn to your supplier for the quantity of hinges which must be fitted to the wardrobe side, depending on the dimensions and weight of your doors.



## Sezione verticale / Vertical section

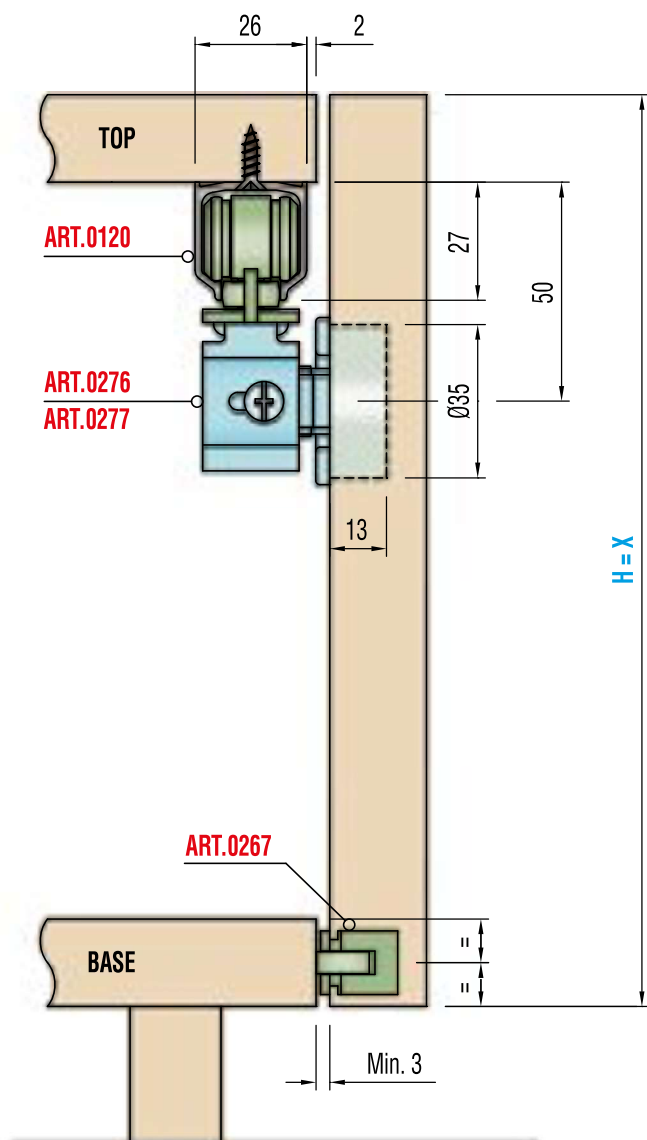

DIMENSIONI ANTE DIMENSIONS OF THE DOORS	
Altezza Height	max. 2000 mm.
Larghezza Width	max. 300 mm.
Spessore Thickness	min. 16 mm. - max. 30 mm.

## Dimensione minima di ingombro / Minimum overall dimension

CON ANTE SPESSORE 20 mm  
WITH DOOR THICKNESS OF 20 mm.

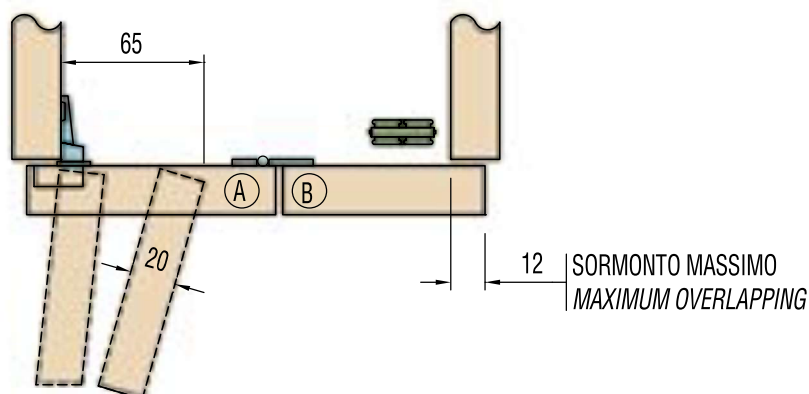



Sistemi scorrevoli per armadi / Folding systems for furniture

## Schema foratura ante / Doors drilling

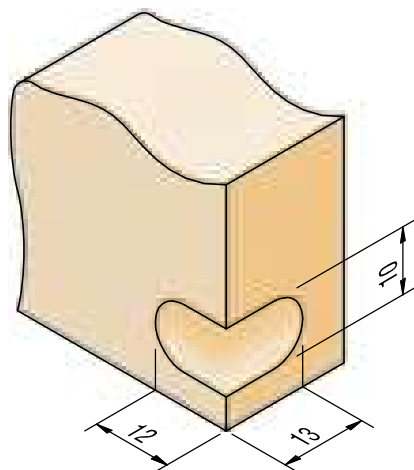
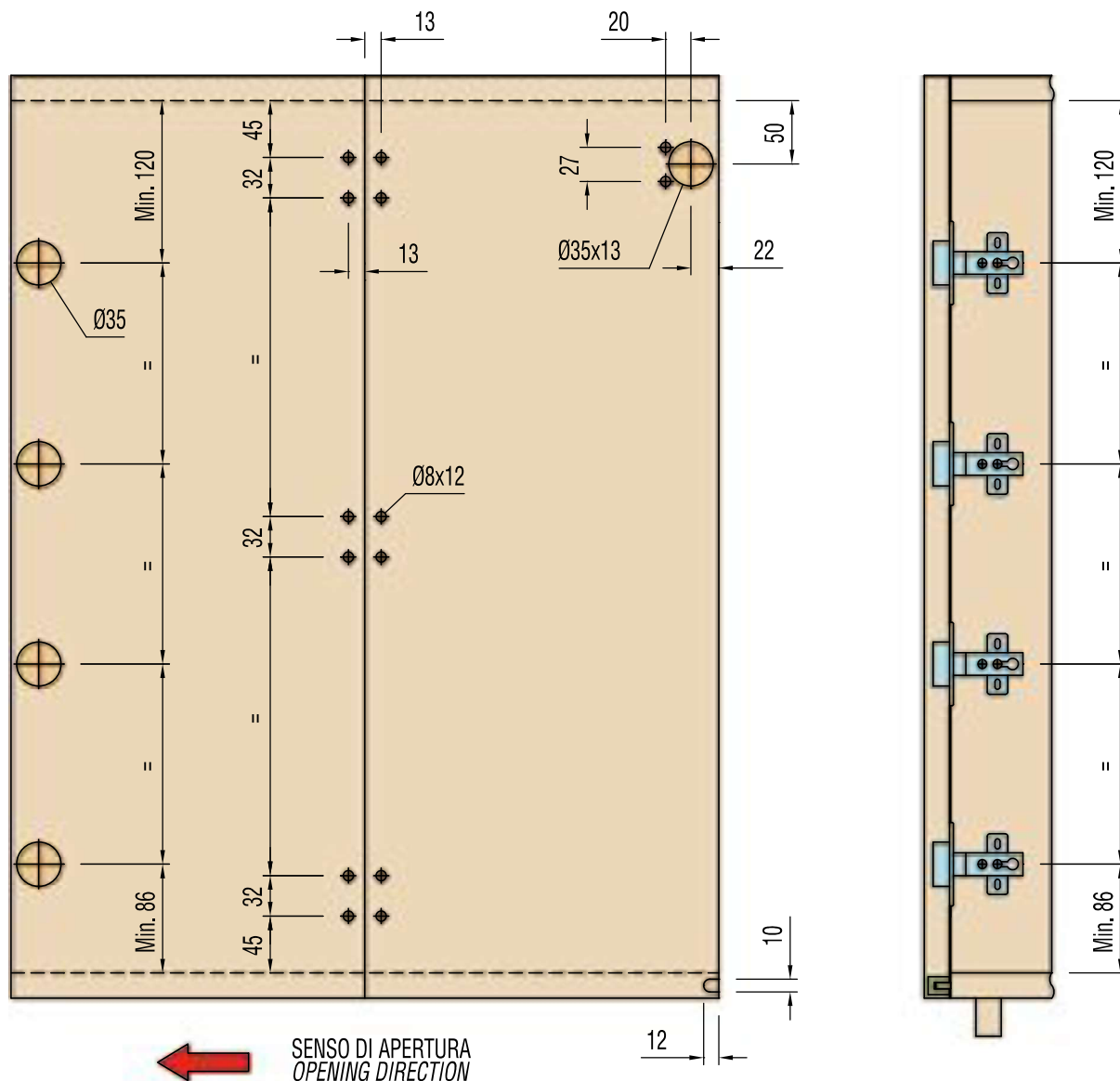

Il peso delle ante deve essere sostenuto dalle cerniere laterali montate sulla spalla del mobile e non dal carrello superiore, che ha la sola funzione di guida. Consultate il vostro fornitore per determinare quante cerniere devono essere montate sulla spalla del mobile, in funzione delle dimensioni e del peso delle vostre ante.

*The weight of the doors is born by the side hinges fitted to the wardrobe side, not by the upper truck which only functions as a guide. Turn to your supplier for the quantity of hinges which must be fitted to the wardrobe side, depending on the dimensions and weight of your doors.*

## Schema di montaggio / Assembling

### SCHEMA MONTAGGIO

Inserire il carrello superiore (ART.0276-0277-0278-0279) nel binario superiore ART.0120.

Avvitare il binario sul top all'interno del mobile e successivamente fissare il carrello superiore all'apposita cerniera precedentemente montata sull'anta.

### ASSEMBLING

Fit the upper truck (ART.0276-0277-0278-0279) into the upper profile ART.0120. Screw the profile onto the top, inside the wardrobe, and then fasten the upper truck to the corresponding hinge fitted to the door.

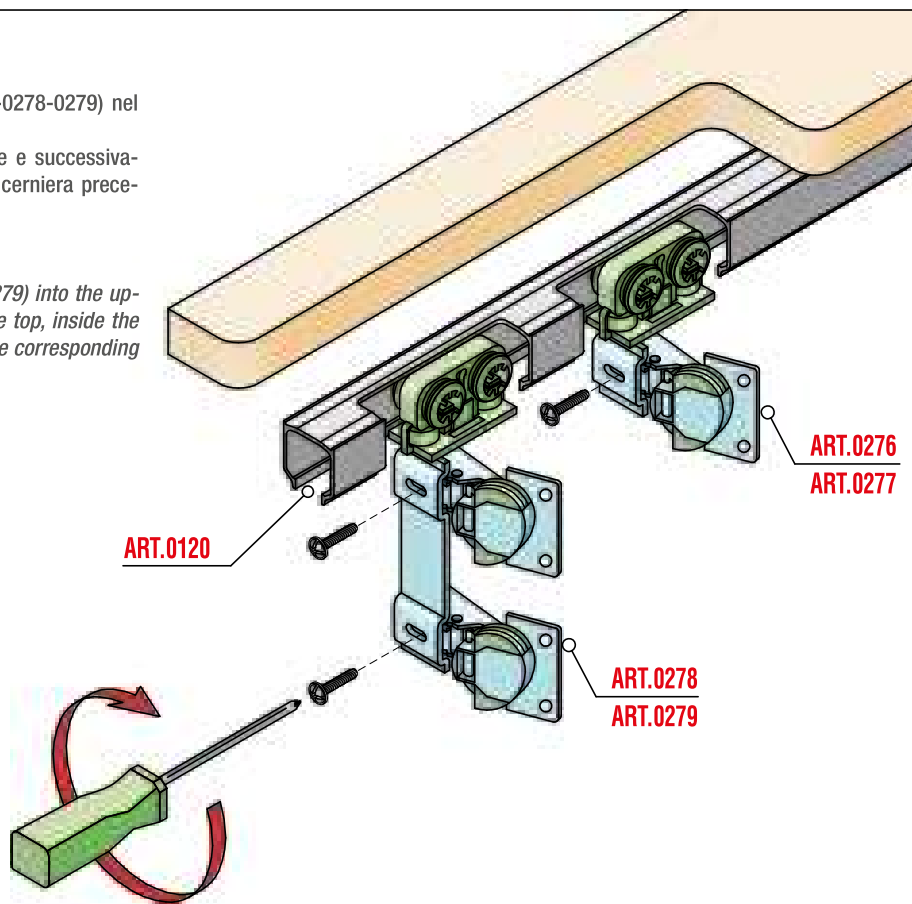

### SCHEMA MONTAGGIO

Avvitare il profilo ART.0823 sulla base del mobile.

Tenere la guida ART.0827 nella corretta posizione sul profilo ART.0823 ed avvitare all'apposita cerniera precedentemente montata sull'anta.

### ASSEMBLING

Screw the profile ART.0823 to the furniture base.

Hold the runner ART.0827 in the proper position on the profile ART.0823 and screw it to the hinge previously fitted to the door.

