

# PROFIL LED SURFACE10 BC/UX 2000 ANOD.



Nawierzchniowe



Meblowe



max 10 mm



- ukryte mocowanie
- szeroka oferta akcesoriów, 7 typów kloszy



Wzory przemysłowe EU



CE



Wyprodukowane w Polsce



Kup produkt

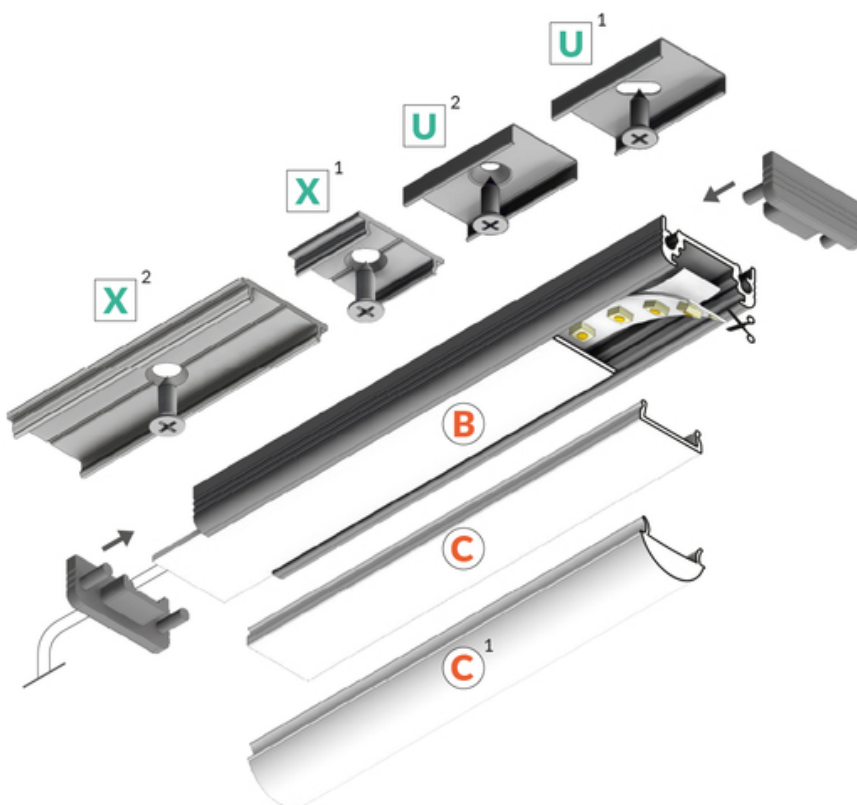
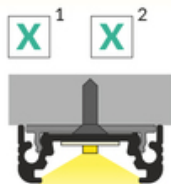
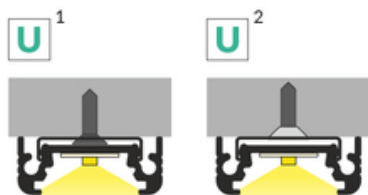
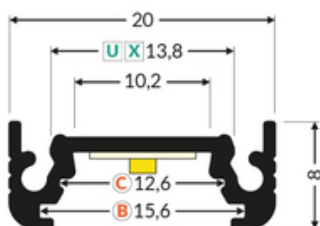

**TOPMET LIGHT KŁOSOWICZ WIŚNIEWSKI sp. z o.o.**

Ostrowska 354 | 61-312 Poznań | POLAND

tel.: +48 61 872 75 00

info@topmet.pl

data wygenerowania karty pdf: 29.08.2024



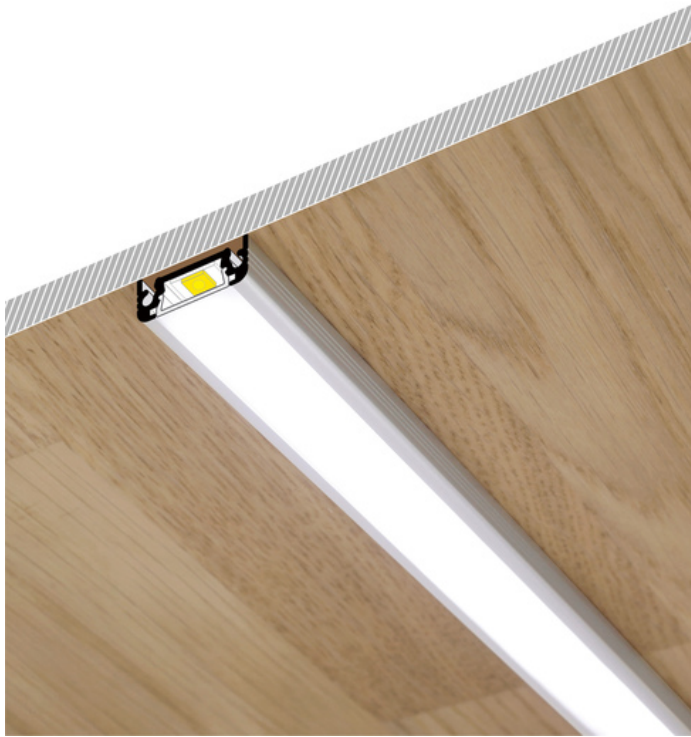

## Informacje podstawowe

<p>Indeks: 77270020 EAN: 5901597201168 Materiał: aluminium Kolor: anodowany Długość [mm]: 2000 Szerokość [mm]: 20 Wysokość [mm]: 8 Waga [kg]: 0.258 Waga opakowania [kg]: 0.018 Producent: TOPMET Kraj pochodzenia, wytworzenia: PL</p>	<p>Jednostka miary: szt. Wymiary opakowania jednostkowego [mm]: 2000 x 20 x 8 Opakowanie zbiorcze [szt]: 40 Typ opakowania zbiorczego: pakiet Waga produktu z opakowaniem zbiorczym [kg]: 10.32</p>
---	---

## DOSTĘPNE KOLORY

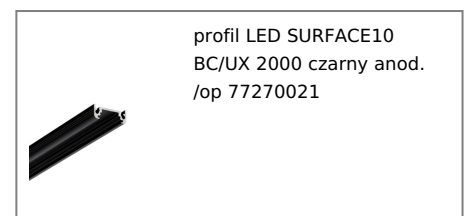
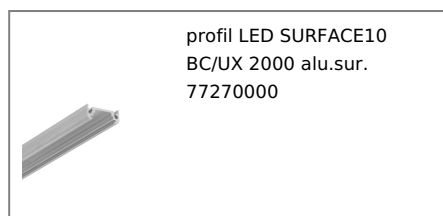
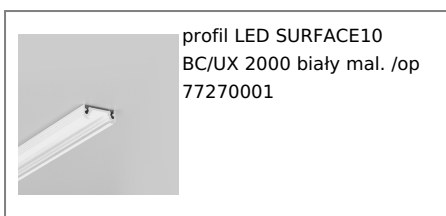

## DOSTĘPNE WARIANTY

1000 mm, 2000 mm, 3000 mm, 4050 mm

## Dopasowane elementy

### KLOSZE DO PROFILI LED

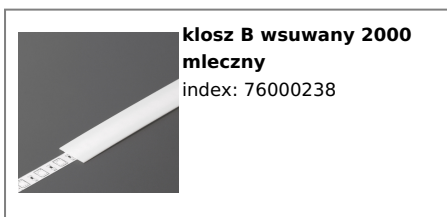

### ZAŚLEPKI DO PROFILI LED

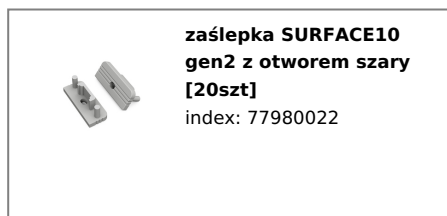

### ŁĄCZNIKI DO PROFILI LED

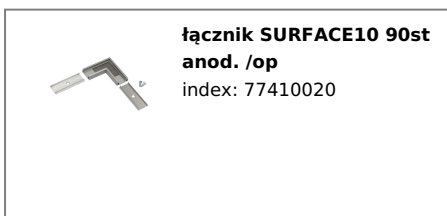

---

## UCHWYTY DO PROFILI LED



**uchwyt U cone inox  
[20szt]**  
index: 76620000

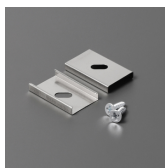

**uchwyt U inox [20szt]**  
index: 76380000



**uchwyt X [20szt]**  
index: 76260000