

PROFIL LED SURFACE10 BC/UX 1000 CZARNY ANOD. /OP



Nawierzchniowe



Meblowe



max 10 mm



- ukryte mocowanie
- szeroka oferta akcesoriów, 7 typów kloszy



CE



Wzory przemysłowe EU



Wyprodukowane w Polsce



Kup produkt

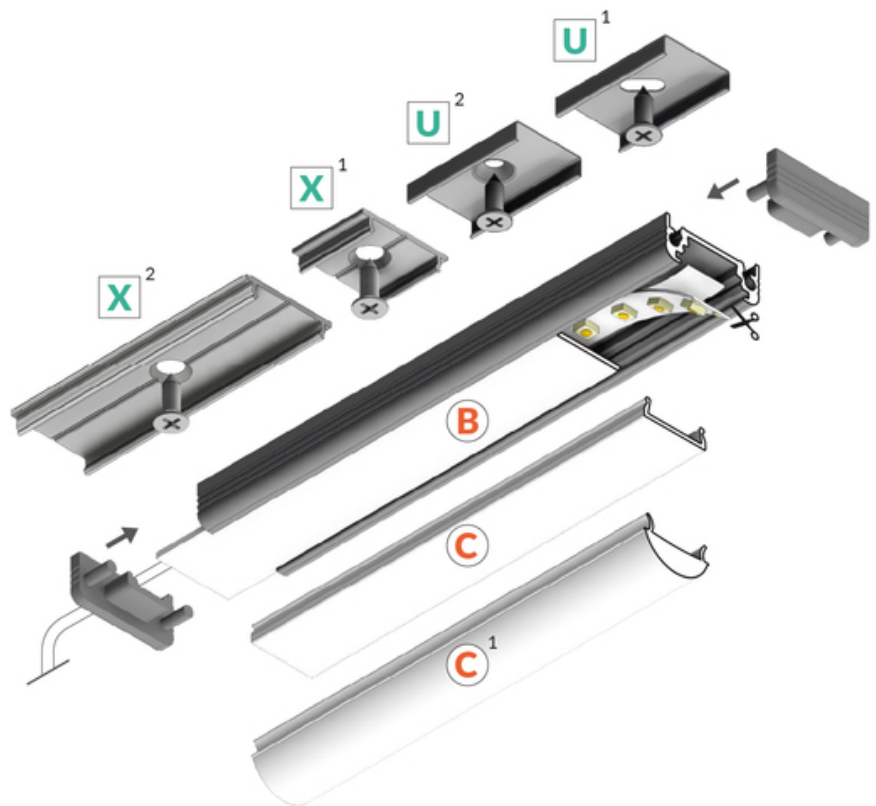
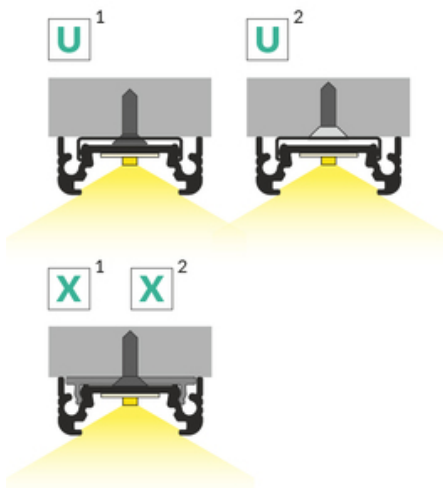
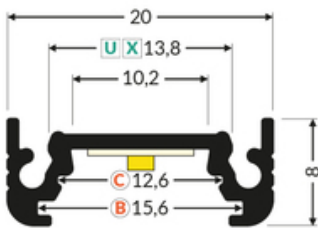

TOPMET LIGHT KŁOSOWICZ WIŚNIEWSKI sp. z o.o.

Ostrowska 354 | 61-312 Poznań | POLAND

tel.: +48 61 872 75 00

info@topmet.pl

data wygenerowania karty pdf: 29.08.2024



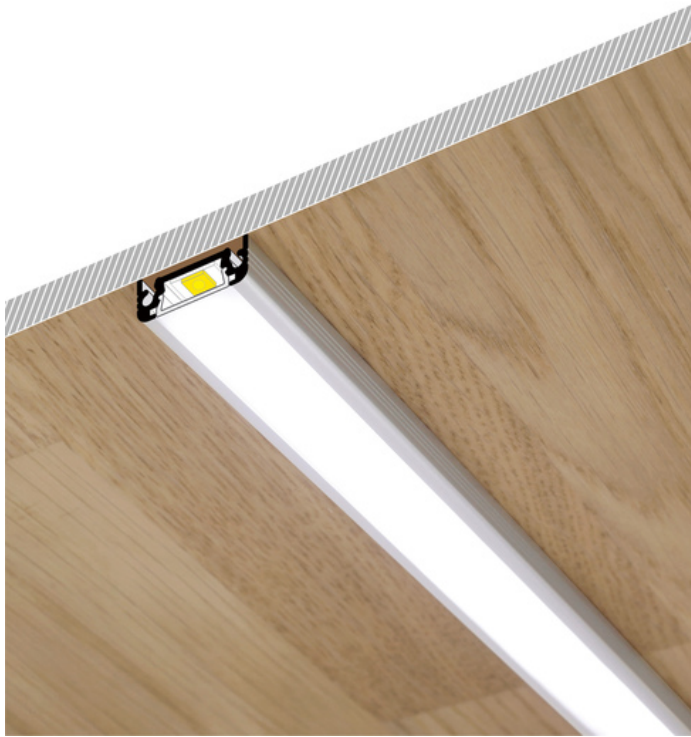



Informacje podstawowe

<p>Indeks: 77260021 EAN: 5901597203643 Materiał: aluminium Kolor: czarny anodowany Długość [mm]: 1000 Szerokość [mm]: 20 Wysokość [mm]: 8 Waga [kg]: 0.135 Waga opakowania [kg]: 0.006 Producent: TOPMET Kraj pochodzenia, wytworzenia: PL</p>	<p>Jednostka miary: szt. Typ opakowania jednostkowego: folia POF Wymiary opakowania jednostkowego [mm]: 1000 x 20 x 8 Opakowanie zbiorcze [szt]: 50 Typ opakowania zbiorczego: karton Waga produktu z opakowaniem zbiorczym [kg]: 7.16</p>
--	--

DOSTĘPNE KOLORY

 <p>profil LED SURFACE10 BC/UX 1000 anod. 77260020</p>	 <p>profil LED SURFACE10 BC/UX 1000 biały mal. /op 77260001</p>	 <p>profil LED SURFACE10 BC/UX 1000 alu.sur. 77260000</p>
---	--	--

DOSTĘPNE WARIANTY

1000 mm, 2000 mm, 3000 mm, 4050 mm

Dopasowane elementy

KLOSZE DO PROFILI LED

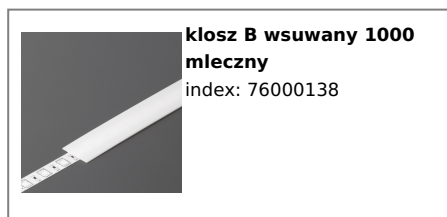

ZASLEPKI DO PROFILI LED



ŁĄCZNIKI DO PROFILI LED

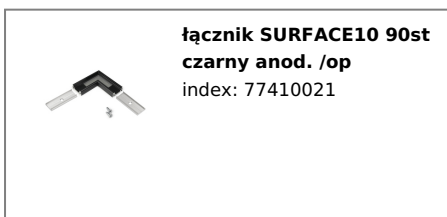

UCHWYTY DO PROFILI LED



**uchwyt U cone inox
[20szt]**
index: 76620000

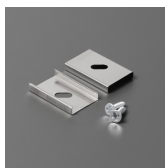

uchwyt U inox [20szt]
index: 76380000



uchwyt X [20szt]
index: 76260000